



SPT/UC SERIES

Sandwich/Salad Prep Units, Undercounter Refrigerators And Freezers

SANDWICH/SALAD PREP UNITS

- SPT-28 SPT-48 SPT-72

UNDERCOUNTER REFRIGERATORS

- UC-28SR UC-48DR UC-72TR

UNDERCOUNTER FREEZERS

- UC-28SF UC-48DF

FEATURES

CONSTRUCTION

- Design meets NSF 7 criteria
- Stainless steel exterior
- Bright white ABS interior on all models except SPT-72 and UC-72TR. These models have stainless steel interior.
- 1³/₄" foamed-in-place "low ODP" urethane insulated walls and doors
- Standard recessed door handles
- Adjustable, heavy-duty wire shelves
- Four 5" diameter casters (2 locking, 2 non-locking)
- Stainless steel louver distributes air to all areas of the unit

- Louver is food acid and stain resistant
- Door width:
 - SPT-28, UC-28SR, UC-28SF27³/₈"
 - SPT-48, SPT-72, UC-48DR, UC-72TR, UC-48DF23⁷/₈"

REFRIGERATION

- Refrigerant:
 - SPT models, UC-R models and UC-28SF R-134a
 - UC-48DF R-404A
- Forced-air refrigeration system
- Two fans for optimum cooling efficiency

- Self-contained, no plumbing required
- Temperature range:
 - SPT and UC-R models 33° to 41°F (1° to 5°C)
 - UC-F models -11° to -3°F (-24° to -19°C)
- R-factor (insulation efficiency rating): 14.58

WARRANTY

- Standard limited four year extended compressor and one year limited parts and labor

OPTIONS

- Legs
- Back splash guard for UC models
- 2" casters for UC models (reduces height to 33¹/₂")



SPT/UC SERIES

SANDWICH/SALAD PREP UNITS, UNDERCOUNTER REFRIGERATORS AND FREEZERS

TECHNICAL SPECIFICATIONS

MODEL	DIMENSIONS (in.)			DIMENSIONS (mm)			VOLTS	AMPS	UNIT H.P.	NO. OF SHELVES	NO. OF 1/6 SIZE PANS**	CAP. CU. FT.	SHIP CU. FT.	SHIP WT. LB/KG
	L	D	H*	L	D	H*								
SANDWICH/SALAD UNITS														
SPT-28	27 ³ / ₄	30	43	705	762	1092	115	5.5	1/4	2	6	6.5	29.0	198/90
SPT-48	48 ¹ / ₄	30	43	1226	762	1092	115	5.0	1/3	4	12	12.0	48.4	264/120
SPT-72	72 ³ / ₄	30	43	1848	762	1092	115	10.8	5/8	6	18	19.0	67.7	385/175
UNDERCOUNTER REFRIGERATORS														
UC-28SR	27 ³ / ₄	30	36	705	762	914	115	4.0	1/5	2	N/A	6.5	24.8	178/81
UC-48DR	48 ¹ / ₄	30	36	1226	762	914	115	4.0	1/5	4	N/A	12.0	40.5	244/111
UC-72TR	72 ³ / ₄	30	36	1848	762	914	115	7.0	1/3	6	N/A	19.0	58.6	340/155
UNDERCOUNTER FREEZERS														
UC-28SF	27 ³ / ₄	30	36	705	762	914	115	7.5	1/3	2	N/A	6.5	24.8	190/86
UC-48DF	48 ¹ / ₄	30	36	1226	762	914	115	11.5	3/5	4	N/A	12.0	40.5	260/118

*Height includes casters. **Pans are 4" deep, 1.5L capacity.

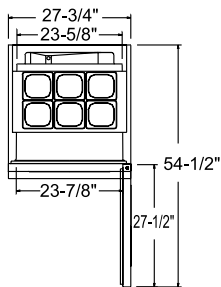

SPT-28

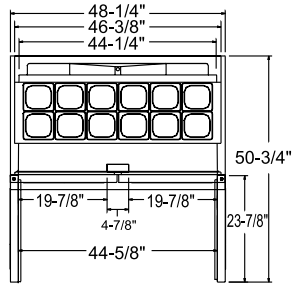

SPT-48

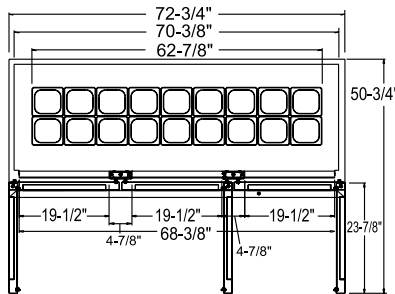

SPT-72

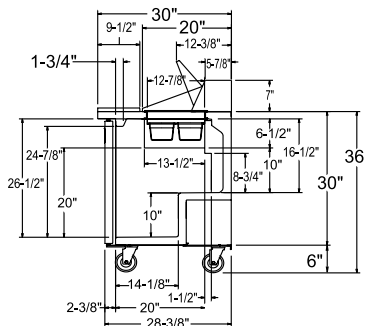

SIDE

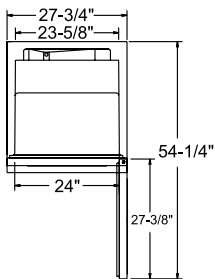

UC-28SR/SF

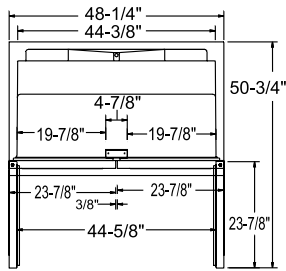

UC-48DR/DF

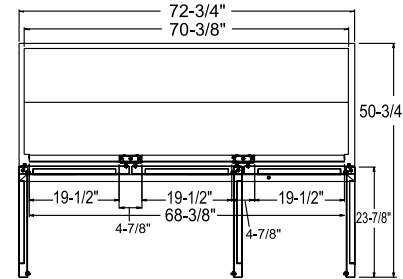

UC-72TR

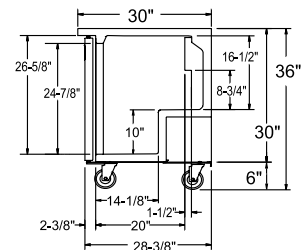

SIDE

LISTINGS

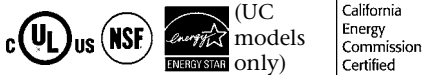

HOOKUP

Via plug in, 10 foot long, flexible 3 wire 16/3 cord with molded plug.



BID SPECIFICATIONS

Item no. SPT-_____ and/or UC-_____. Provide _____ () Sandwich/Salad Preparation Units and/or Undercounter Refrigerators or Freezers, Master-Bilt model no. SPT-_____ and/or UC-_____.

Model design will meet NSF 7 criteria. Exterior finish will be stainless steel. Units will have bright white ABS interior except for SPT-

72 and UC-72TR which will be stainless steel. Standard features include adjustable, heavy-duty wire shelves and 5" diameter casters. All doors to have standard recessed handles.

SPT models, UC-R models and UC-28SF will contain R-134a refrigerant. UC-48DF will contain R-404A. The temperature range for SPT and UC-R models will be 33° to 41°F (1° to

5°C). The range for UC-F models will be -11° to -3°F (-24° to -19°C). All models to have a standard limited 4 year extended compressor and one year limited parts and labor warranty. Cabinets to be UL, C-UL and NSF listed and California Energy Commission certified. UC models to be Energy Star certified.

NOTE: Cabinet designed for optimum performance in air-conditioned area at 75°F ambient and 55% relative humidity. All specifications subject to change without notice.

